

PRODUCT FEATURES

- ANSI Designation: M91
- Line Voltage: 120/208/240/277
- Regulation: 5%
- Frequency: 60 Hz
- Recommended Fuse (A): 5/4/3/3
- Circuit Type: HX-HPF
- Insulation Class: 180°C
- Capacitor Value: 12 MF
- Capacitor Voltage Rating: 280 V
- Capacitor Temperature Rating: 90°C
- Winding Materials: Cu/Cu
- Lamp Starter: XG-04
- Agency Certification: RU, cRU
- Maximum Distance to Lamp: 10 FT
- 2 Year Warranty

LAMP TYPE: 100W MH

INPUT VOLTAGE: Quad (120/208/240/277)

CIRCUIT TYPE: HX-HPF

ELECTRICAL SPECIFICATIONS

LINE VOLT (V)	POWER FACTOR	LINE CURRENT			INPUT POWER (W)	OPEN CIRCUIT VOLTAGE (V)	MINIMUM START TEMP	UL TEMP CODE	WIRING DIAGRAM
		OPERATING	OPEN	START					
120	High	1.20	2.32	1.30	125	280	-40°C	A	H5
208	High	0.67	1.39	0.90	132	290	-40°C	A	H5
240	High	0.58	1.16	0.60	125	280	-40°C	A	H5
277	High	0.50	1.00	0.48	125	280	-40°C	A	H5

WIRING DIAGRAMS

DIAGRAM H5

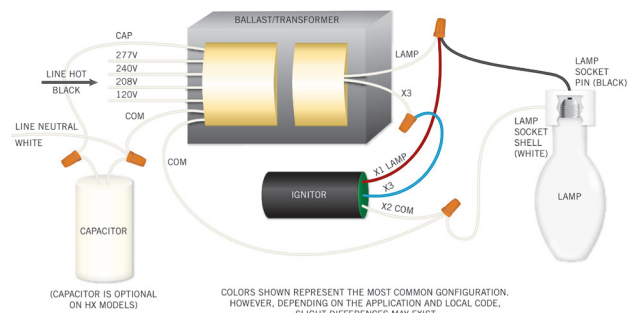
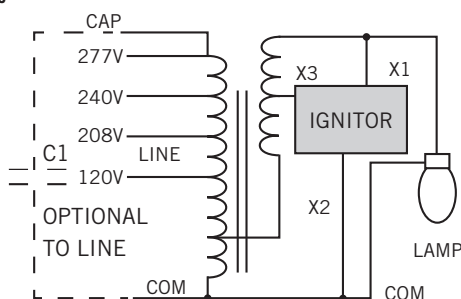

CASE STYLE/DIMENSIONS

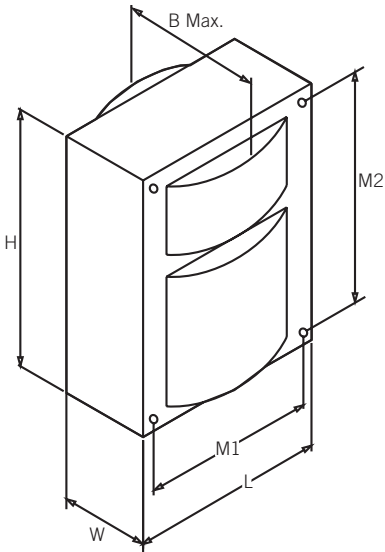

OVERALL DIMENSIONS

LENGTH: 2.80"
WIDTH: 1.58"
HEIGHT: 3.94"
B MAX: 2.95"

MOUNTING HOLES

DIAMETER: 0.25"
M1: 2.44"
M2: 3.50"

BRACKET DIMENSIONS

LENGTH: 5.50"
WIDTH: 1.25"

LEAD LENGTH: 12-14"

BALLAST NET WEIGHT: 5.07 lbs

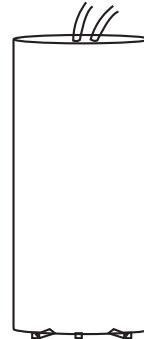

CAPACITOR INFO

WATTAGE: 100
MICROFARAD: 12
VOLTAGE: 280
TYPE: Dry Film



IGNITOR INFO

LAMP TYPE: Pulse Start Metal Halide
WATTAGE: 50-150
TYPE: HX

ORDERING INFORMATION

ORDER CODE	PACKAGING STYLE	PACK QTY.	ITEM STATUS
MH-100X-Q-KIT		1	Quick Ship
*Kit Includes: Pre-Wired Ballast, Capacitor, Ignitor, Mounting Brackets, Mounting Hardware			

CATALOG NUMBER BREAKDOWN

MH-100X-Q-KIT

